









Socket Comfort







# Socket Comfort – at one glance

	ClearSil. compression	ClearSil.basic	ClearSil.stabil	ClearSil.cushion
Walky System				
Pear-shaped BK stump (trans-tibial stump) 	××× post-operative	××		×
Normal cylindrical, BK stump (trans-tibial stump) 	××× post-operative	××	××	××
Bony conical BK stump (trans-tibial stump) 				××× for pressure-sensitive residual limb ends
Cylindrical AK-stump (trans-femoral stump) 	××× post-operative			
Conical AK-stump (trans-femoral stump) 	××× post-operative			

××× = optimal      ×× = good      × = suitable

Please see the introductory pages of this catalogue for more information about our Walky-system.

DuoSil.basic	ComfortSil.basic ComfortSil.soft	ClassicSil.basic ClassicSil.soft	AK-Control.Sil	ContexGel.basic ContexGel.soft ContecGel.soft+
				
×	×	×	×	×
	3 mm basic	3 mm basic		×
×	×	×	×	×
	3 mm basic	3 mm basic	for large BK-stumps	×
×	×	×		×
	6 mm soft	6 mm soft		×
			×	×
				use 3 mm version only
			×	×
				use 3 mm version only

# Socket Comfort

In orthopaedic technology, prosthetic care with silicone and polymer-gel-liners has been modern standard since approx. 20 years.

Accordingly, the term “polymer” means that the cushioning material has been made of “many identical particles”. Silicone is a polymer material as well, excellently suitable for cushioning purposes in orthopaedic technology.

The softer and thicker the polymer layer is; the less suitable it is for higher activities resp. the shorter the lifespan of the polymer. Polymer-liners target the user group with level 1 or 3 in our walky-system or with very sensitive, bony residual limbs.

The thinner and more solid the polymer layer is, the more control of the prosthetic socket is provided and therefore it is suitable for patients with higher activity. The more solid material is usually silicone and therefore it is more durable than softer polymer. The user group for these liners usually are classified 2 to 4 in our walky-system.



### **Benefits of Liners by Streifeneder ortho.production GmbH for the user**

- Maximum wearing comfort of the prosthetic socket
- Punctual and surface cushioning for bony, scarred and difficult residual limbs
- Shape stability for excess soft tissue
- Targeted stump compression for reduction and prevention of oedema; post operative and preventative
- Reduction of stump volume changes (stump fluctuations)
- Reduced elongation due to integrated, textile reinforcement
- Skin caring ingredients such as medical white oil provide protection and care
- Safe adaption between user's stump and prosthesis by means of proven pin- or cord lock or vacuum socket technology (VST)
- Simple handling, easy cleaning and guaranteed longevity
- Easy rolling up and down of the liner due to smooth fabric cover
- Less restraining prosthetic care possible (renouncement of high condylar guard or upper thigh cuff with lateral splint guard)

### **Features**

- Additives with aseptic surface effects
- Improved polymer features
- Distal rotation control for more stability
- Anti-rotation strips for above-knee liners AK-Control.Sil 60L1
- New functional cover fabric

# Socket Comfort – FAQs

## **Skin irritations in the area of the liner edge (little blisters on the skin)?**

Skin irritations sometimes appear at the liner edge upon first use of polymer-liners. Usually, cutting the liner edge into shape with a pair of scissors helps. When cutting, the cutting edge can be broken with a small pair of half-round scissors. Another reason is putting on the liner under tension. Especially for problems in the rear, upper thigh area, a thinner liner is recommendable. Additionally, in order to minimize friction, the skin in the edge area can be coated with skin cream (e.g. Skin Protection Cream 10H3).

## **Skin irritations on the entire residual limb skin?**

Generally, the inside of all silicone and polymer-gel-liners must be washed prior to first use with lots of warm water and pH-neutral soap (e.g. with Skin-Care-Washing Lotion 10H2) and then dried with a paper towel. A new prosthesis always creates a new skin situation in the liner and every user may react in a different way. At the beginning, excessive sweating in the liner may lead to allergic reactions and therefore, hygiene is very important. The solution for this is also very careful washing of the liner with neutral soap (10H2) and lots of water.

Another reason for allergic reactions in connection with damage of the liner material may be caused by medication, which releases substances through the skin pores due to natural metabolic processes and lead to a chemical reaction with sweat. If this is the cause, a medical doctor or dermatologist must be consulted.

## **Excessive sweating in the liner does not stop. What could be the cause?**

If excessive and permanent sweating in the liner continues, size and fit of the liner in the prosthetic socket must be checked. Air locked in between residual limb skin and liner may lead to excessive sweating.

## **The BK-prosthesis wearer complains about red skin above and on the knee cap?**

Usually, it already helps to unroll the liner over a slightly bent knee, in order to reduce the skin tension in this area.

## **The pin is never positioned straight in the socket?**

Possible causes are either the stump position in the phase of putting the liner on with the result of an unfortunate flexion angle during entering the prosthetic socket. Or, a very distinctive socket shape, which squeezes the residual limb together with the liner into a certain direction when entering. Both will lead to unilateral friction spots in the hopper area of the locking system.

Putting the liner cup transversally onto the stump end may solve the problem.

Generally, already during plaster casting, the centered pin position at the liner must be considered, in order to avoid the above mentioned problems later.

### How do I care for the liner?

All liners must be carefully cleaned with Skin-Care-Washing Lotion 10H2 prior to first use, in order to remove possible residues from manufacturing and to avoid skin irritations.

Daily cleaning of the liner with Skin-Care-Washing Lotion 10H2 prevents skin irritations and extends the life time of the liner. For heavy-duty use, the liner may be put on each day in a position turned by a few centimeters, this will provide even wear.



# Socket Comfort – Silicone Liners

## Features of Silicone Liners by Streifeneder ortho.production GmbH

### Liners with quality seal

To improve the hygienic conditions for liner wearers, we use special additives which produce an aseptic surface effect. One of our additives is "Sterione" and is supplied by a company with the same name, SteriOne GmbH. This patented technology grants that the treated liner material permanently inhibits infestation of bacteria and micro-organisms. The liners sold by Streifeneder ortho.production GmbH have been awarded a quality seal and are approved as "antibacterial". The symbol shown below indicates the use of Sterione for antibacterial effect. This effect has also been approved by one more, independent testing institute

### The quality seal grants

- Effectiveness period of at least five years
- Elimination of 5 million germs per hour and square-centimeter



### The application of Sterione effectively prevents

- bacteria growth (e.g. pneumococco-bacilli and multi-resistant micro-organisms such as MRSA)
- Test strains *Staphylococcus aureus* and *Escherichia coli*

### Rotation control of Comfort.Sil Liner, Classic.Sil Liner and AK-Control.Sil Liner

- More rotation stability between liner and prosthetic socket
- Better guidance and control of the BK-prosthesis

### AK-Control.Sil Liner 60L1 with anti rotation strips

- More rotation stability between liner and prosthetic socket
- Better guidance and control of the BK-prosthesis

### Silver-grey fabric coating with improved features (rolling characteristics, longevity) of the silicone liners

- Recognition value for all Silicone Liners with fabric cover





## Benefits of Silicone Liners by Streifeneder ortho.production GmbH

- Excellent cleaning properties by closed-pore surface
- Outstanding skin comfort, as silicone is physiologically safe
- Oils contained in the silicone moisturise the residual limb skin
- Thin liner wall provides at the same time good shape stability
- Good circular elasticity for stump fluctuations
- Low longitudinal tension of silicone liners with fabric cover
- Positive compression benefits the stump
- Excellently suited for early care (interim care)
- Resistant against body fluids, chlorine and UV-light; sterilisable at approx. 120 °C (248 °F)
- Special sizes with matrix length of up to 18 cm available upon request

## How to choose the correct liner

### 1. Step

Size determination for a silicone liner – Measure the distal circumference approx. 4 cm above the tip of the stump. The first two numbers indicate the basic size, e. g. measured circumference 28 cm = size 28

Please order the silicone liner without fabric cover as follows

- For the initial supply two to three sizes smaller
- For the follow-up supply one to two sizes smaller

Please order the silicone liner with fabric cover as follows

- For the initial supply one to two sizes smaller
- For the follow-up supply zero to one size smaller

Please take these calculated values only as a guideline, since each patient has his or her individual requirements.

### 2. Step

Finding the correct matrix length for a silicone liner – The precise length of the stump as well as the structure of the bones is decisive for selecting the correct interior laminate.

We recommend

- A minimum of 6 cm into the bony structure
- Ending below the fibula head (distally) at the most

Customized model: We can manufacture special design liners with a matrix of 5 cm for very short stumps and liners up to 18 cm for long stumps.

### 3. Step

Trimming the silicone liner

- Easily cut the rim of the liner as desired using a pair of scissors.
- The reversal-safe intermeshing of the jersey fabric allows for a problem-free and individual trimming of the liner.



# Socket Comfort – Silicone Liners



## ClearSil.compression

Post surgical compression liner without internal matrix and without distal connection



total length: approx. 370 mm



### Designated use

- targeted stump compression after leg amputation
- early accommodation to silicone liner use
- early forming of the stump

### Characteristics

- silicone liner without internal matrix and without distal connection
- controlled compression
- bandaging not necessary, therefore no restriction due to wrong bandaging
- enhances blood circulation and reduces edema accumulation
- heat resistant, therefore suitable for steam sterilisation at 120 °C

### Material

- wall thickness: see sketch
- Clear-Sil-Silicone, firm, antibacterially fitted
- approx. 53 Shore 00
- without textile cover
- colour: translucent

### Warranty

- 12 months

Size	Item-No.
23,5, 25, 26,5, 28, 30, 32, 34, 36, 38, 40, 42, 45	1S22/..

Ordering example 1S22/23,5 = size 23,5

**S** For application of silicone liners without textile lining, skin care spray 10H5 must be used. Please use the supplied compression chart for documentation of the residual limb volume.

without picture

## ClearSil.compression Sets

Post surgical compression liner sets in various sizes

- application, characteristics and material like item 1S22

Set	Content	Item-No.
1	sizes 23,5, 25, 26,5	1S22/1
2	sizes 28, 30, 32, 34	1S22/2
3	sizes 36, 38, 40	1S22/3

# Socket Comfort – Silicone Liners



## ClearSil.basic

Silicone liner without internal matrix, with and without distal connection

### Designated use

- activity level (walky): 2 to 4
- well-suited for short residual limbs
- interim prostheses and early applications

### Characteristics

- silicone liner without internal matrix
- with and without distal connection
- distally very elastic
- due to the high stability, very suitable for medium active wearers of prostheses
- compresses the stump
- heat resistant, therefore suitable for steam sterilisation at 120 °C

### Material

- wall thickness: see sketch
- Clear-Sil-Silicone, firm, antibacterially fitted
- approx. 53 Shore 00
- without textile cover
- colour: translucent

### Warranty

- 12 months



Dimension sketch:

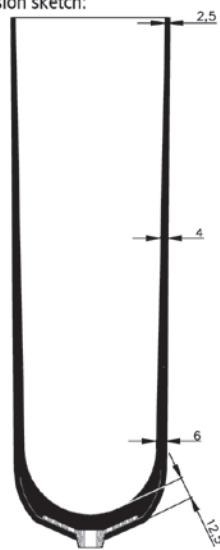

Size	Distal connection	Item-No.
12, 14, 16, 18, 20, 21, 22, 23,5, 25, 26,5, 28, 30, 32, 34, 36, 38, 40, 42, 45	with	1S3/..
12, 14, 16, 18, 20, 21, 22, 23,5, 25, 26,5, 28, 30, 32, 34, 36, 38, 40, 42, 45	without	1S4/..

Ordering example: 1S3/12 = with distal connection, size 12



**Sizing:** Measure the distal circumference approx. 4 cm above the stump end and select the liner in the same size or one size smaller. For application of silicone liners without textile lining skin care spray 10H5 must be used.

total length: approx. 370 mm



# Socket Comfort – Silicone Liners



## DuoSil.basic

Two layer silicone liner with 10 cm internal matrix, with distal connection, made of DuoSil-Silicone

### Designated use

- activity level (walky): 1 to 3
- suitable as a basic fitting for medium active patients
- suitable for difficult stump conditions

### Characteristics

- two layer silicone liner
- with very soft internal silicone layer for high wearing comfort and optimal damping
- harder silicone layer on the outside gives the liner stability and tear resistance
- 10 cm inner matrix reduces axial expansion
- with distal connection

### Material

- wall thickness: see sketch
- DuoSil-Silicone, antibacterially fitted
- internal layer: approx. 40 Shore 00, external layer: approx. 50 Shore 00
- without textile cover
- colour: peach

### Warranty

- 12 months

### Custom-made liners

All sizes of liners with different internal matrix of 5 - 18 cm length can be manufactured within 3 - 5 working days at no extra costs. All customized liners are reduced to a 3 months warranty.



Dimension sketch:

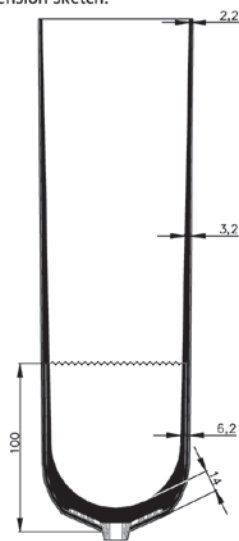

Size	Internal matrix	Item-No.
16, 18, 20, 21, 22, 23,5, 25, 26,5, 28, 30, 32, 34, 36, 38, 40, 42, 45	10 cm	1S18/..

Ordering example: 1S18/16 = size 16



**Sizing:** Measure the distal circumference approx. 4 cm above the stump end and select the liner in the same size or one size smaller. For application of silicone liners without textile lining skin care spray 10H5 must be used.

total length: approx. 370 mm



# Socket Comfort – Silicone Liners



## ComfortSil.basic

Silicone Liner made of soft 3 mm Comfort-Sil-Silicone

### Designated use

- activity level (walky): 1 to 3
- suitable as a basic fitting for geriatric patients
- for pressure sensitive patients

### Characteristics

- optimal wearing comfort and damping
- especially soft functional textile cover for easily rolling the liner up or down
- functional textile cover minimises longitudinal expansion
- excellent circular expansion adjusts to volume changes at the residual limb
- item 40L110: integrated 10 cm long matrix reduces the distal elongation at the residual limb
- distal rotation control supports guidance of prosthesis
- available with distal connections for all Streifeneder pin types and locking systems
- available without distal connection and rotation control for vacuum-socket-technology (VST)

### Material

- wall thickness: 3 mm, see sketch
- Comfort-Sil-Silicone, soft, antibacterially fitted
- approx. 26 Shore 00
- abrasion-proof textile cover made of polyamide/elastane
- item 40L110 with PUR-rotation control
- colour: silver grey

### Warranty

- 6 months



Dimension sketch:

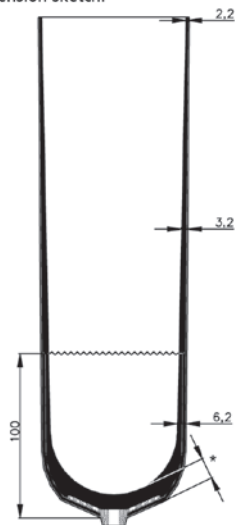

\* 14 mm without distal connection  
18,5 mm with distal connection

total length: approx. 370 mm

Size	Wall thickness	Internal matrix	Distal connection	Item-No.
16, 18, 20, 21, 22, 23,5, 25, 26,5, 28, 30, 32, 34, 36, 38, 40, 42, 45	3 mm	10 cm	with	40L110/..
16, 18, 20, 21, 22, 23,5, 25, 26,5, 28, 30, 32, 34, 36, 38, 40, 42, 45	3 mm	without	without	40L200/..

Ordering example: 40L110/16 = with distal connection, size 16. Scope of supply includes stand.

**Sizing:** Measure the distal circumference approx. 4 cm above the stump end and select the liner in the same size or one size smaller.



# Socket Comfort – Silicone Liners



## ComfortSil.soft

Silicone liner made of soft 6 mm Comfort-Sil-Silicone

### Designated use

- activity level (walky): 1 to 3
- suitable as a basic fitting for geriatric patients
- for pressure sensitive patients
- for bony residual limbs with low soft tissue coverage

### Characteristics

- optimal wearing comfort and damping
- especially soft functional textile cover for easily rolling the liner up or down
- functional textile cover minimises longitudinal expansion
- excellent circular expansion adjusts to volume changes at the residual limb
- item 41L110: integrated 10 cm long matrix reduces the distal elongation at the residual limb
- distal rotation control supports guidance of prosthesis
- available with and without distal connection
- suitable for all Streifeneder pin types and locking systems

### Material

- wall thickness: 6 mm, see sketch
- Comfort-Sil-Silicone, soft, antibacterially fitted
- approx. 26 Shore 00
- abrasion-proof textile cover made of polyamide/elastane
- item 41L110 with PUR-rotation control
- colour: silver grey

### Warranty

- 6 months



Dimension sketch:

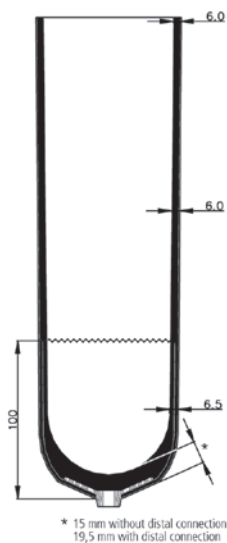

Size	Wall thickness	Internal matrix	Distal connection	Item-No.
16, 18, 20, 21, 22, 23,5, 25, 26,5, 28, 30, 32, 34, 36, 38, 40, 42, 45	6 mm	10 cm	with	41L110/..
16, 18, 20, 21, 22, 23,5, 25, 26,5, 28, 30, 32, 34, 36, 38, 40, 42, 45	6 mm	without	without	41L200/..

Ordering example: 41L110/16 = with distal connection, size 16. Scope of supply includes stand.

**Sizing:** Measure the distal circumference approx. 4 cm above the stump end and select the liner in the same size or one size smaller.

total length: approx. 370 mm



# Socket Comfort – Silicone Liners



## ClassicSil.basic

Silicone Liner made of 3 mm stable two layer Duo-Sil-Silicone

### Designated use

- activity level (walky): 2 to 4
- excellently suitable for standard care
- for normal pressure-sensitive users with sufficient soft tissue coverage
- „allrounder“

### Characteristics

- optimal wearing comfort and damping
- especially soft functional textile cover for easily rolling the liner up or down
- functional textile cover minimises longitudinal expansion
- excellent circular expansion adjusts to volume changes at the residual limb
- item 50L110: integrated 10 cm long matrix reduces the distal elongation at the residual limb
- distal rotation control supports guidance of prosthesis
- available with and without distal connection
- suitable for all Streifeneder pin types and locking systems

### Material

- wall thickness: 3 mm, see sketch
- two layer Duo-Sil-Silicone, stable, antibacterially fitted
- internal layer (on the skin): 26 Shore 00
- middle layer: 53 Shore 00
- abrasion-proof textile cover made of polyamide/elastane
- item 50L110 with PUR-rotation control
- colour: silver grey

### Warranty

- 12 months



Dimension sketch:

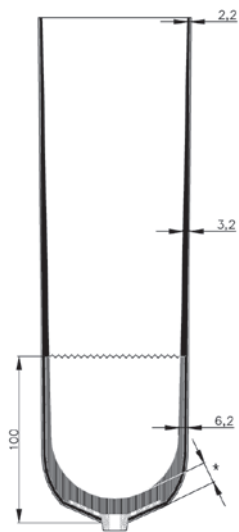

total length: approx. 370 mm

Size	Wall thickness	Internal matrix	Distal connection	Item-No.
16, 18, 20, 21, 22, 23,5, 25, 26,5, 28, 30, 32, 34, 36, 38, 40, 42, 45	3 mm	10 cm	with	50L110/..
16, 18, 20, 21, 22, 23,5, 25, 26,5, 28, 30, 32, 34, 36, 38, 40, 42, 45	3 mm	without	without	50L200/..

Ordering example: 50L110/16 = with distal connection, size 16. Scope of supply includes stand.



**Sizing:** Measure the distal circumference approx. 4 cm above the stump end and select the liner in the same size or one size smaller.





# Socket Comfort – Silicone Liners



## ClassicSil.soft

Silicone liner made of 6 mm two layer stable Duo-Sil-Silicone

### Designated use

- activity level (walky): 2 to 4
- excellently suitable for standard care
- for pressure-sensitive users with low soft tissue coverage

### Characteristics

- optimal wearing comfort and damping
- especially soft functional textile cover for easily rolling the liner up or down
- functional textile cover minimises longitudinal expansion
- excellent circular expansion adjusts to volume changes at the residual limb
- item 51L110: integrated 10 cm long matrix reduces the distal elongation at the residual limb
- distal rotation control supports guidance of prosthesis
- available with and without distal connection
- suitable for all Streifeneder pin types and locking systems

### Material

- wall thickness: 6 mm, see sketch
- two layer Duo-Sil-Silicone, stable, antibacterially fitted
- internal layer (on the skin): 26 Shore 00
- middle layer: 53 Shore 00
- abrasion-proof textile cover made of polyamide/elastane
- item 51L110 with PUR-rotation control
- colour: silver grey

### Warranty

- 12 months



Dimension sketch:

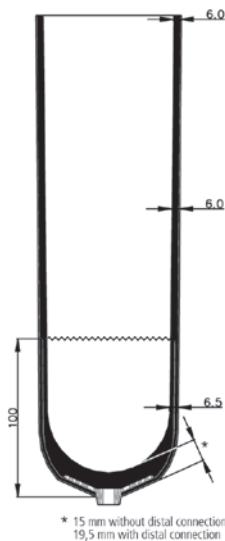

total length: approx. 370 mm



Size	Wall thickness	Internal matrix	Distal connection	Item-No.
16, 18, 20, 21, 22, 23,5, 25, 26,5, 28, 30, 32, 34, 36, 38, 40, 42, 45	6 mm	10 cm	with	51L110/..
16, 18, 20, 21, 22, 23,5, 25, 26,5, 28, 30, 32, 34, 36, 38, 40, 42, 45	6 mm	without	without	51L200/..

Ordering example: 51L110/16 = with distal connection, size 16. Scope of supply includes stand.

**Sizing:** Measure the distal circumference approx. 4 cm above the stump end and select the liner in the same size or one size smaller.

# Socket Comfort – Silicone Liners



## AK-Control.Sil

Trans-femoral silicone liner made of medium stable Control-Sil-Silicone, with distal connection and anti-rotation strips

### Designated use

- activity level (walky): 1 to 4
- ideal for liner-care of above-knee amputations and for care of voluminous below-knee amputations

### Characteristics

- 2 mm wall thickness for controlled expansion in the socket entry zone
- outer matrix (sewed-on strip) for reduction of longitudinal expansion (inhibited longitudinal expansion)
- anti-rotation strips on the outer matrix prevent twisting between liner and prosthetic socket
- especially soft functional textile cover for easily rolling the liner up or down
- very good radial expansion adjusts to volume changes of the residual limb
- rotation control to improve guidance of prosthesis
- with distal connection for all Streifeneder pin types and locking systems

### Material

- wall thickness: 2 mm, see sketch
- Control-Sil-Silicone, medium stable, antibacterially fitted
- approx. 40 Shore 00
- abrasion-proof textile cover made of polyamide/elastane
- three rows of silicone stripes on the textile strip in vertical direction
- with PUR-rotation control
- colour: silver grey / black

### Warranty

- 6 months



width of textile strip: 38 mm

Size	Wall thickness	Item-No.
25, 26,5, 28, 30, 32, 34, 36, 38, 40, 42, 45, 50, 55	2 mm	60L1/..

Ordering example: 60L1/25 = size 25. Scope of supply does include stand.

**Sizing:** Measure the distal circumference approx. 4 cm above the stump end and select the liner in the same size or one size smaller.

Dimension sketch:



total length: approx. 370 mm



# Socket Comfort – Silicone Liners

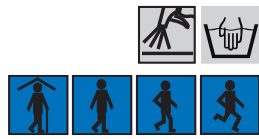

## AK-Control.Sil

Trans-femoral silicone liner made of medium stable Control-Sil-Silicone, with distal connection, without anti-rotation strips

### Designated use

- activity level (walky): 1 to 4
- ideal for liner-care of above-knee amputations and for care of voluminous below-knee amputations

### Characteristics

- 2 mm wall thickness for controlled expansion in the socket entry zone
- outer matrix (sewed-on strip) for reduction of longitudinal expansion (inhibited longitudinal expansion)
- especially soft functional textile cover for easily rolling the liner up or down
- very good radial expansion adjusts to volume changes of the residual limb
- rotation control to improve guidance of prosthesis
- with distal connection for all Streifeneder pin types and locking systems

### Material

- wall thickness: 2 mm, see sketch
- Control-Sil-Silicone, medium stable, antibacterially fitted
- approx. 40 Shore 00
- abrasion-proof textile cover made of polyamide/elastane
- crosswise elastic textile strip to limit longitudinal stroke
- with PUR-rotation control
- colour: silver grey / black

### Warranty

- 6 months



width of textile strip: 20 mm

Size	Wall thickness	Item-No.
25, 26,5, 28, 30, 32, 34, 36, 38, 40, 42, 45, 50, 55	2 mm	60L5/..

Ordering example: 60L5/25 = size 25. Scope of supply does include stand.

**Sizing:** Measure the distal circumference approx. 4 cm above the stump end and select the liner in the same size or one size smaller.

Dimension sketch:



total length: approx. 370 mm





# Socket Comfort – Gel Liners

## Benefits of Gel-Liners

- „Flow characteristics“ (viscoelasticity) of the polymer gel provide even pressure distribution in the socket; e.g. significantly reduce pressure- and shear forces
- Medical white oils in the polymer gel provide care for the stressed stump skin and maintain the natural skin moisture
- Contex-Gel Liners are mouldable at 60 °C – for optimal adaption to unusual stump shapes
- Various ventral wall thicknesses (3, 6, 9 mm) with constant thin dorsal wall thickness (3 mm); e.g. additional cushioning for soft tissue substitution especially in pressure sensitive areas
- Conical liner shape for better adaption to most stump conditions
- Available with distal connection for all pin types and lock series sold by Streifeneder ortho.production
- Available without distal connection for targeted stump moulding and for vacuum socket technology (VST)
- Excellently suited for prosthetic care of below-knee residual limbs, knee-ex articulations and above-knee residual limbs
- For users with difficult stumps and low to medium activity



# Socket Comfort – Gel Liners

## Benefits of Gel-Liners

### Hints for the technician / user

Streifeneder Polymer Gel has been dermatologically tested, inhibits bacteria and is hydro allergenic. It absorbs pressure, is protective and has a skin-care effect and therefore makes the Contex-Gel-Liner very comfortable.

Gel-Liner require softly moulded prosthetic sockets! Edgy moulded socket shapes create possible pressure points at small surfaces, which may lead to premature material fatigue. Sharp prosthetic socket edges also cause premature tear of the ContexGel products. Please consider this when manufacturing the prosthetic socket and construct rounded edges.

Do not select a liner too small, as this may reduce the shock absorption characteristics (see Contex-Gel-Liner measuring chart).

The liner should not be shortened more than 10 cm circular above the socket edge.

Before first use, all Contex-Gel products must be cleaned with Skin-Care-Washing Lotion 10H2 and lots of warm water.

Generally, daily cleaning of the Contex-Gel-Liner resp. the Contex-Gel-Knee Sleeve is mandatory.

Please sensitize the users for these recommendations.

All products made of Streifeneder polymer gel are easy to clean. Cleaning does not affect their features. For cleaning, we recommend our pH-neutral washing lotion 10H2 and lots of warm water to rinse off the soap. After washing, the Contex-Gel-Liner is dried on the supplied liner stand. Usually, washing is done every evening / day, so enable the liner to dry at night.



# Socket Comfort – Gel Liners



## ContexGel.basic

ContexGel-Liner, 3 mm, made of soft ContexGel

### Designated use

- activity level (walky): 1 to 3
- for above-knee and below-knee amputees
- suitable to substitute soft tissue at the residual limb end
- for bony, pressure sensitive or difficult leg stumps

### Characteristics

- thermoplastic mouldable at 60 °C (140 °F)
- optimal wearing comfort and good shock absorption in the entire stump area
- especially soft functional textile cover for easily rolling the liner up or down
- functional textile cover minimises longitudinal expansion
- excellent circular expansion adjusts to volume changes at the residual limb
- distal rotation control supports guidance of prosthesis
- available with distal connections for all Streifeneder pin types and locking systems
- available without distal connection for vacuum system technology (VST)

### Material

- wall thickness: 3 mm, conical shape
- soft ContexGel with medical white oil, antibacterially fitted
- approx. 25 – 30 Shore 00
- abrasion-proof textile cover made of polyamide/elastane
- item 20L100 with PUR-rotation control
- colour: anthracite

### Warranty

- 6 months



Dimension sketch:

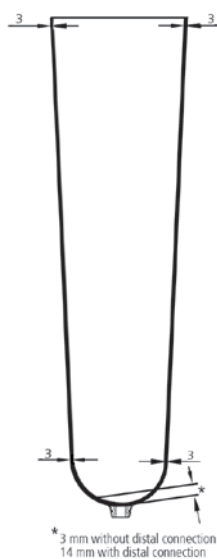

total length: approx. 420 mm



Size	Distal	Proximal	Distal connection	Item-No.
S	16 – 23 cm	25 – 36 cm	with	20L100/S
M	19 – 30 cm	30 – 43 cm	with	20L100/M
L	24 – 34 cm	38 – 58 cm	with	20L100/L
XL	28 – 39 cm	41 – 63 cm	with	20L100/XL
XXL	32 – 44 cm	43 – 69 cm	with	20L100/XXL
S	16 – 23 cm	25 – 36 cm	without	20L200/S
M	19 – 30 cm	30 – 43 cm	without	20L200/M
L	24 – 34 cm	38 – 58 cm	without	20L200/L
XL	28 – 39 cm	41 – 63 cm	without	20L200/XL
XXL	32 – 44 cm	43 – 69 cm	without	20L200/XXL

Scope of supply does include stand.

# Socket Comfort – Gel Liners



## ContexGel.basic

ContexGel-Liner, 3 mm, made of soft ContexGel, with outer matrix

### Designated use

- activity level (walky): 1 to 3
- for above-knee and below-knee amputees
- suitable to substitute soft tissue at the residual limb end
- for bony, pressure sensitive or difficult leg stumps

### Characteristics

- thermoplastic mouldable at 60 °C (140 °F)
- optimal wearing comfort and good shock absorption in the entire stump area
- especially soft functional textile cover for easily rolling the liner up or down
- outer matrix limits longitudinal stroke in the distal area
- functional textile cover minimises longitudinal expansion
- excellent circular expansion adjusts to volume changes at the residual limb
- distal rotation control supports guidance of prosthesis
- available with distal connections for all Streifeneder pin types and locking systems
- available without distal connection for vacuum system technology (VST)

### Material

- wall thickness: 3 mm, conical shape
- soft ContexGel with medical white oil, antibacterially fitted
- approx. 25 – 30 Shore 00
- abrasion-proof textile cover made of polyamide/elastane
- item 25L100 with PUR-rotation control
- colour: anthracite

### Warranty

- 6 months



Dimension sketch:

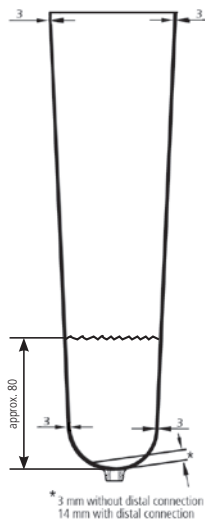

total length: approx. 420 mm



Size	Distal	Proximal	Distal connection	Item-No.
S	16 – 23 cm	25 – 36 cm	with	25L100/S
M	19 – 30 cm	30 – 43 cm	with	25L100/M
L	24 – 34 cm	38 – 58 cm	with	25L100/L
XL	28 – 39 cm	41 – 63 cm	with	25L100/XL
XXL	32 – 44 cm	43 – 69 cm	with	25L100/XXL
S	16 – 23 cm	25 – 36 cm	without	25L200/S
M	19 – 30 cm	30 – 43 cm	without	25L200/M
L	24 – 34 cm	38 – 58 cm	without	25L200/L
XL	28 – 39 cm	41 – 63 cm	without	25L200/XL
XXL	32 – 44 cm	43 – 69 cm	without	25L200/XXL

Scope of supply does include stand.



# Socket Comfort – Gel Liners



## ContexGel.soft

ContexGel-Liner, anterior wall thickness 6 mm, posterior wall thickness 3 mm, made of soft ContexGel

### Designated use

- activity level (walky): 1 to 3
- for below-knee amputees
- suitable to substitute soft tissue at the tibia edge and stump end
- for bony and difficult leg stumps

### Characteristics

- thermoplastic mouldable at 60 °C (140 °F)
- optimal wearing comfort and very good shock absorption in the anterior stump area
- especially soft functional textile cover for easily rolling the liner up or down
- thinner wall thickness in the posterior dorsal area improves knee flexion at prosthetic socket
- functional textile cover minimises longitudinal expansion
- excellent circular expansion adjusts to volume changes at the residual limb
- distal rotation control supports guidance of prosthesis
- available with distal connections for all Streifeneder pin types and locking systems
- available without distal connection for vacuum system technology (VST)

### Material

- anterior wall thickness 6 mm, posterior wall thickness 3 mm, conical shape
- soft ContexGel with medical white oil, antibacterially fitted
- approx. 25 – 30 Shore 00
- abrasion-proof textile cover made of polyamide/elastane
- item 21L100 with PUR-rotation control
- colour: anthracite

### Warranty

- 6 months



Dimension sketch:



\* 4,5 mm without distal connection  
14 mm with distal connection

total length: approx. 420 mm



Size	Distal	Proximal	Distal connection	Item-No.
S	16 – 23 cm	25 – 36 cm	with	21L100/S
M	19 – 30 cm	30 – 43 cm	with	21L100/M
L	24 – 34 cm	38 – 58 cm	with	21L100/L
XL	28 – 39 cm	41 – 63 cm	with	21L100/XL
XXL	32 – 44 cm	43 – 69 cm	with	21L100/XXL
S	16 – 23 cm	25 – 36 cm	without	21L200/S
M	19 – 30 cm	30 – 43 cm	without	21L200/M
L	24 – 34 cm	38 – 58 cm	without	21L200/L
XL	28 – 39 cm	41 – 63 cm	without	21L200/XL
XXL	32 – 44 cm	43 – 69 cm	without	21L200/XXL

Scope of supply does include stand.

# Socket Comfort – Gel Liners



## ContexGel.soft

ContexGel-Liner, anterior wall thickness 6 mm, posterior wall thickness 3 mm, made of soft ContexGel, with outer matrix

### Designated use

- activity level (walky): 1 to 3
- for below-knee amputees
- suitable to substitute soft tissue at the tibia edge and stump end
- for bony and difficult leg stumps

### Characteristics

- thermoplastic mouldable at 60 °C (140 °F)
- optimal wearing comfort and very good shock absorption in the anterior stump area
- especially soft functional textile cover for easily rolling the liner up or down
- outer matrix limits longitudinal stroke in the distal area
- thinner wall thickness in the posterior dorsal area improves knee flexion at prosthetic socket
- functional textile cover minimises longitudinal expansion
- excellent circular expansion adjusts to volume changes at the residual limb
- distal rotation control supports guidance of prosthesis
- available with distal connections for all Streifeneder pin types and locking systems
- available without distal connection for vacuum system technology (VST)

### Material

- anterior wall thickness 6 mm, posterior wall thickness 3 mm, conical shape
- soft ContexGel with medical white oil, antibacterially fitted
- approx. 25 – 30 Shore 00
- abrasion-proof textile cover made of polyamide/elastane
- item 26L100 with PUR-rotation control
- colour: anthracite

### Warranty

- 6 months



Dimension sketch:

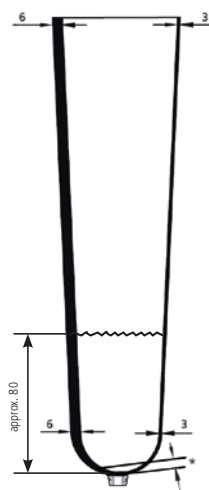

total length: approx. 420 mm

Size	Distal	Proximal	Distal connection	Item-No.
S	16 – 23 cm	25 – 36 cm	with	26L100/S
M	19 – 30 cm	30 – 43 cm	with	26L100/M
L	24 – 34 cm	38 – 58 cm	with	26L100/L
XL	28 – 39 cm	41 – 63 cm	with	26L100/XL
XXL	32 – 44 cm	43 – 69 cm	with	26L100/XXL
S	16 – 23 cm	25 – 36 cm	without	26L200/S
M	19 – 30 cm	30 – 43 cm	without	26L200/M
L	24 – 34 cm	38 – 58 cm	without	26L200/L
XL	28 – 39 cm	41 – 63 cm	without	26L200/XL
XXL	32 – 44 cm	43 – 69 cm	without	26L200/XXL

Scope of supply does include stand.



# Socket Comfort – Gel Liners



## ContexGel.soft+

ContexGel-Liner, anterior wall thickness 9 mm, posterior wall thickness 3 mm, made of soft ContexGel

### Designated use

- activity level (walky): 1 to 3
- for below-knee amputees
- suitable to substitute soft tissue at the tibia edge and stump end
- for bony, very pressure sensitive or difficult leg stumps

### Characteristics

- thermoplastic mouldable at 60 °C (140 °F)
- optimal wearing comfort and excellent shock absorption in the anterior stump area
- especially soft functional textile cover for easily rolling the liner up or down
- thinner wall thickness in the posterior dorsal area improves knee flexion at prosthetic socket
- functional textile cover minimises longitudinal expansion
- excellent circular expansion adjusts to volume changes at the residual limb
- distal rotation control supports guidance of prosthesis
- available with distal connections for all Streifeneder pin types and locking systems
- available without distal connection for vacuum system technology (VST)

### Material

- wall thickness: anterior wall thickness 9 mm, posterior wall thickness 3 mm, conical shape
- soft ContexGel with medical white oil, antibacterially fitted
- approx. 25 – 30 Shore 00
- abrasion-proof textile cover made of polyamide/elastane
- item 22L100 with PUR-rotation control
- colour: anthracite

### Warranty

- 6 months



Dimension sketch:



total length: approx. 420 mm



Size	Distal	Proximal	Distal connection	Item-No.
S	16 – 23 cm	25 – 36 cm	with	22L100/S
M	19 – 30 cm	30 – 43 cm	with	22L100/M
L	24 – 34 cm	38 – 58 cm	with	22L100/L
XL	28 – 39 cm	41 – 63 cm	with	22L100/XL
XXL	32 – 44 cm	43 – 69 cm	with	22L100/XXL
S	16 – 23 cm	25 – 36 cm	without	22L200/S
M	19 – 30 cm	30 – 43 cm	without	22L200/M
L	24 – 34 cm	38 – 58 cm	without	22L200/L
XL	28 – 39 cm	41 – 63 cm	without	22L200/XL
XXL	32 – 44 cm	43 – 69 cm	without	22L200/XXL

Scope of supply does include stand.

# Socket Comfort – Gel Liners



## ContexGel.soft+

ContexGel-Liner, anterior wall thickness 9 mm, posterior wall thickness 3 mm, made of soft ContexGel, with outer matrix

### Designated use

- activity level (walky): 1 to 3
- for below-knee amputees
- suitable to substitute soft tissue at the tibia edge and stump end
- for bony, very pressure sensitive or difficult leg stumps

### Characteristics

- thermoplastic mouldable at 60 °C (140 °F)
- optimal wearing comfort and excellent shock absorption in the anterior stump area
- especially soft functional textile cover for easily rolling the liner up or down
- thinner wall thickness in the posterior dorsal area improves knee flexion at prosthetic socket
- functional textile cover minimises longitudinal expansion
- outer matrix limits longitudinal stroke in the distal area
- excellent circular expansion adjusts to volume changes at the residual limb
- distal rotation control supports guidance of prosthesis
- available with distal connections for all Streifeneder pin types and locking systems
- available without distal connection for vacuum system technology (VST)

### Material

- wall thickness: anterior wall thickness 9 mm, posterior wall thickness 3 mm, conical shape
- soft ContexGel with medical white oil, antibacterially fitted
- approx. 25 – 30 Shore 00
- abrasion-proof textile cover made of polyamide/elastane
- item 27L100 with PUR-rotation control
- colour: anthracite

### Warranty

- 6 months



Dimension sketch:

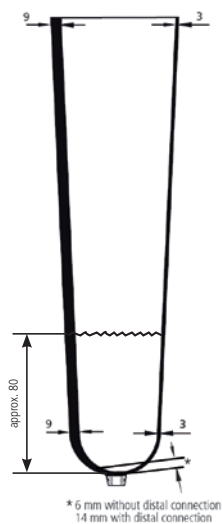

total length: approx. 420 mm



Size	Distal	Proximal	Distal connection	Item-No.
S	16 – 23 cm	25 – 36 cm	with	27L100/S
M	19 – 30 cm	30 – 43 cm	with	27L100/M
L	24 – 34 cm	38 – 58 cm	with	27L100/L
XL	28 – 39 cm	41 – 63 cm	with	27L100/XL
XXL	32 – 44 cm	43 – 69 cm	with	27L100/XXL
S	16 – 23 cm	25 – 36 cm	without	27L200/S
M	19 – 30 cm	30 – 43 cm	without	27L200/M
L	24 – 34 cm	38 – 58 cm	without	27L200/L
XL	28 – 39 cm	41 – 63 cm	without	27L200/XL
XXL	32 – 44 cm	43 – 69 cm	without	27L200/XXL

Scope of supply does include stand.

# Socket Comfort – Application Aids

The application aids ContexGel.Knee Sleeve (30L1 and 30L5), AK- and BK-Suspenders (300A1 and 23A1) by Streifeneder ortho.production provide correct support and position of leg prostheses. Especially in vacuum socket technology (VST) for below-knee short prostheses, a closed system without air intrusion is very important. The ContexGel.Knee Sleeve works like a knee- resp. sealing cap; and prevents intrusion of air and together with the exhaust valve (6P50, Active.valve) safely holds the leg prosthesis at the residual limb of the user.

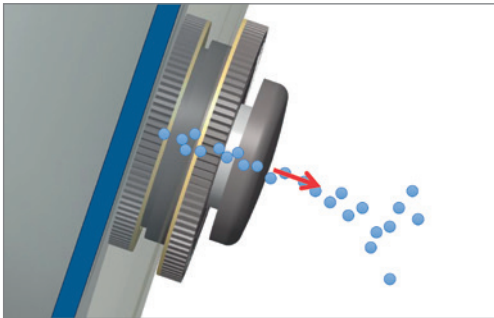

exhaust phase – the compressed air is released through the valve

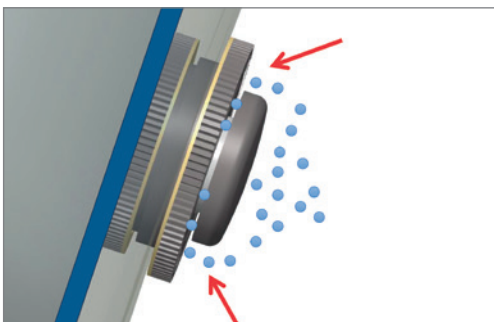

comfort phase – the vacuum can be regulated by pressing the button

When standing up and in stance phase, the exhaust valve provides a continuous vacuum, which prevents the leg prosthesis from slipping away and therefore minimizes uncomfortable shear- and friction forces on the residual limb. Defined pressure balance can be achieved by using the easy-to-reach pressure button; to take load off the prosthesis user's residual limb, e.g. while sitting.

Traditional varieties of prosthetic applications can be found in a modern version in our AK-Suspenders and BK-Suspenders. These so-called holding supports for above-knee and below-knee prostheses also provide correct connections and at the same time support the guidance of leg prostheses.

## Benefits for the user

- Easier putting the prosthesis on and better wearing guidance of the prosthesis with our without exhaust valve or liner system
- Slip resistant materials at the inside prevent slipping of the prosthetic socket
- Stable and reinforced transversely elastic fabrics optimally adapt to the stump shape
- Wide range of size variety covers individual user conditions



# Socket Comfort – Application Aids



## ContexGel.sleeve

ContexGel knee sleeve, 3 mm uniform

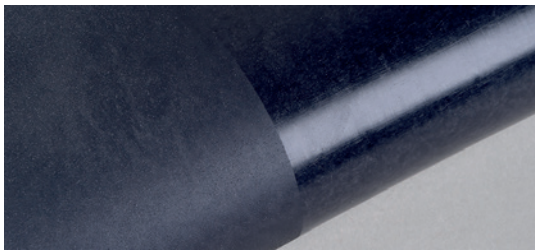

satined knee area of the inner surface



### Designated use

- ContexGel-Knee Sleeves are suitable for below-knee amputees as knee holding support or as sealing cap for vacuum-socket technology (VST)
- additional guidance for the knee and stabilisation for short prostheses
- smaller sizes are used as holding supports in arm prosthetics

### Characteristics

- thermoplastic mouldable at 60 °C (140 °F)
- satined knee area prevents tension sensations in the knee joint area
- for optimal hold in the distal and proximal area
- especially soft functional textile cover for easily rolling the liner up or down
- functional textile cover minimises longitudinal expansion
- excellent circular expansion adjusts to the socket- and stump-anatomy
- product recommendation additionally for vacuum-socket technology (VST)

### Material

- wall thickness: 3 mm, conical shape
- soft ContexGel with medical white oil, antibacterially fitted
- approx. 25 – 30 Shore 00
- abrasion-proof textile cover made of polyamide/elastane
- colour: anthracite 30L1 / sand 30L5

### Warranty

- 3 months

Colour: Anthracite

Size	Distal	Proximal	Length	Item-No.
S	15 – 23 cm	23 – 35 cm	37 cm	30L1/S
M	21 – 31 cm	29 – 44 cm	37 cm	30L1/M
L	28 – 43 cm	36 – 52 cm	38,5 cm	30L1/L
XL	34 – 48 cm	42 – 58 cm	38,5 cm	30L1/XL
XXL	38 – 52 cm	43 – 64 cm	38,5 cm	30L1/XXL

Colour: Sand

Size	Distal	Proximal	Length	Item-No.
S	15 – 23 cm	23 – 35 cm	37 cm	30L5/S
M	21 – 31 cm	29 – 44 cm	37 cm	30L5/M
L	28 – 43 cm	36 – 52 cm	38,5 cm	30L5/L
XL	34 – 48 cm	42 – 58 cm	38,5 cm	30L5/XL
XXL	38 – 52 cm	43 – 64 cm	38,5 cm	30L5/XXL

# Socket Comfort – Application Aids



## ContexGel.protect

Protective cover for ContexGel.sleeve



### Designated use

- protective cover for sharp-edged prosthetic sockets

### Characteristics

- expandable protective cover prevents premature tear of the ContexGel knee sleeves
- the protective cover is worn underneath the ContexGel knee sleeve
- the distal inner side is equipped with a silicone edge, which prevents slipping at the prosthetic socket
- additional adhering not necessary

### Material

- durable and expandable functional fabric, made of polyurethane/polyamide/elastane
- colour: black

### Warranty

- 6 months

Size	Side	For knee sleeve	Length	Item-No.
S	universal	size S	19 cm	3S50/S
M	universal	size M	19 cm	3S50/M
L	universal	size L	22 cm	3S50/L
XL	universal	size XL + XXL	22 cm	3S50/XL



# Socket Comfort – Application Aids



## AK-Suspender

AK-Prosthesis Support



scope of supply does not include components

### Designated use

- fixes a prosthesis at the user's pelvis and prevents slipping of the prosthesis from the residual limb
- the suspender is used to support above-knee (AK-) suspension sockets, if sufficient vacuum cannot be achieved

### Characteristics

- facilitates putting the prosthesis on and improves guidance during wearing the AK-prosthesis without rubber valve or liner system
- slip resistant, elastic neoprene at the inside of the leg section adheres to the socket
- stable, reinforced transversely elastic material in the pelvic / hip area optimally adjusts to the body shape
- individual adjustment options by two frontal hook- and loop fasteners

### Material

- leg section: 100 % neoprene (cellular rubber), outer textile lining: 100 % polyamide (PA)
- pelvic section: 46 % polyamide (PA), 30 % viscose (CV), 24 % elasthane (EL)
- colour: silver/anthracite
- machine washable at 30 °C

Size	Hip circ.	Circ. medial/ socket edge	Side	Item-No.
S	60 – 74 cm	36 – 40 cm	right	300A1/RS
M	66 – 80 cm	40 – 44 cm	right	300A1/RM
L	76 – 90 cm	44 – 48 cm	right	300A1/RL
XL	86 – 100 cm	48 – 52 cm	right	300A1/RXL
XXL	96 – 110 cm	52 – 56 cm	right	300A1/RXXL
S	60 – 74 cm	36 – 40 cm	left	300A1/LS
M	66 – 80 cm	40 – 44 cm	left	300A1/LM
L	76 – 90 cm	44 – 48 cm	left	300A1/LL
XL	86 – 100 cm	48 – 52 cm	left	300A1/LXL
XXL	96 – 110 cm	52 – 56 cm	left	300A1/LXXL

# Socket Comfort – Application Aids



## BK-Suspender

Knitted Holding Aid for BK-protheses



scope of supply does not include components

### Designated use

- additional fixation of the BK-prosthesis at the leg; prevents slipping of the prosthesis of the residual limb
- supports the prosthesis guidance
- supports and takes load off the knee joint capsule when wearing a short prosthesis

### Characteristics

- high circular elasticity, nearly no elasticity in the vertical area
- anatomical, flexional shape

### Material

- 75 % PA polyamid, 25 % EL elasthan (without latex)
- colour: silver/anthracite

### Warranty

- 3 months

PU = 2 pieces

Size	Circ. distal	Circ. proximal	Length	Item-No.
S	26 – 30 cm	34 – 38 cm	35 cm	23A1/S
M	29 – 33 cm	38 – 42 cm	35 cm	23A1/M
L	32 – 36 cm	42 – 46 cm	35 cm	23A1/L
XL	35 – 39 cm	46 – 50 cm	35 cm	23A1/XL

For right and left side.

## Rubber Suspension Sleeve



- for swimming/bathing protheses
- with reinforcement at top and bottom

Length	Proximal	Distal	Item-No.
450 mm	360 mm	200 mm	4P70/K
450 mm	380 mm	230 mm	4P70/M
450 mm	400 mm	230 mm	4P70/G

# Socket Comfort – Application Aids



## Slide.fit

Slip-on aid for above knee prostheses

### Designated use

- slip-on aid for above knee prostheses (for suspension sockets)

### Characteristics

- the gliding material surface of the slip-on aid simplifies putting on the above-knee prosthesis
- long and stiffened sliding aid simplifies application through valve opening of the prosthetic socket
- due to the large grip-tongue, pulling out through the valve opening becomes more energy-saving
- contrast colour stitching for size identification

### Material

- fabric: 100 % PA polyamide
- coating: 100 % PUR polyurethane

### Warranty

- 3 months

PU = 1 pc. with storage bag

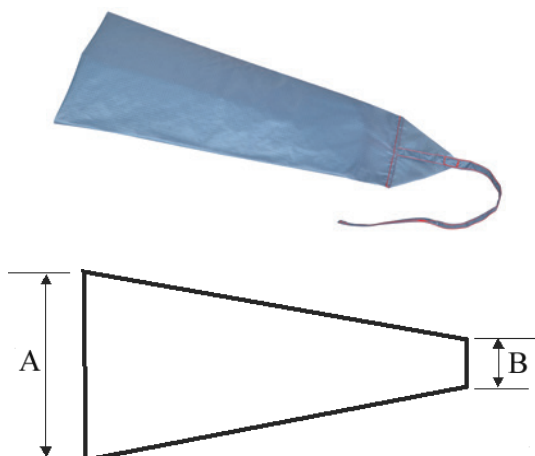

Stump circ. distal up to (B)	Stump circ. proximal up to (A)	Length of donning aid	Colour	Item-No.
24 cm	40 cm	43 cm	yellow	17A1/XS
26 cm	44 cm	50 cm	red	17A1/S
28 cm	56 cm	50 cm	dark blue	17A1/M
30 cm	68 cm	50 cm	green	17A1/L
36 cm	76 cm	52 cm	light blue	17A1/XL
38 cm	88 cm	60 cm	orange	17A1/XXL



## DAW-Slipper

Slip-on aid for above knee prostheses

### Designated use

- slip-on aid for above knee prostheses (for suspension sockets)

### Characteristics

- the smooth outside helps sliding into the AK prosthesis easier
- the loop of approx. 80 cm length helps pulling in and out through the valve opening
- very durable nylon quality with reinforced distal end
- original DAW product

### Material

- 100 % PA (nylon), colour: white
- very fine, smooth and openly knitted quality
- the knitting technique prevents ladders
- machine washable at 30 °C



AK-circumference	Length	Item-No.
26 - 32 cm	50 cm	13A2/1
33 - 40 cm	50 cm	13A2/2
41 - 50 cm	50 cm	13A2/3
51 - 60 cm	50 cm	13A2/4
61 - 70 cm	50 cm	13A2/5

 AK-circumference must be measured at the height of the upper prosthesis socket.

# Socket Comfort – Application Aids

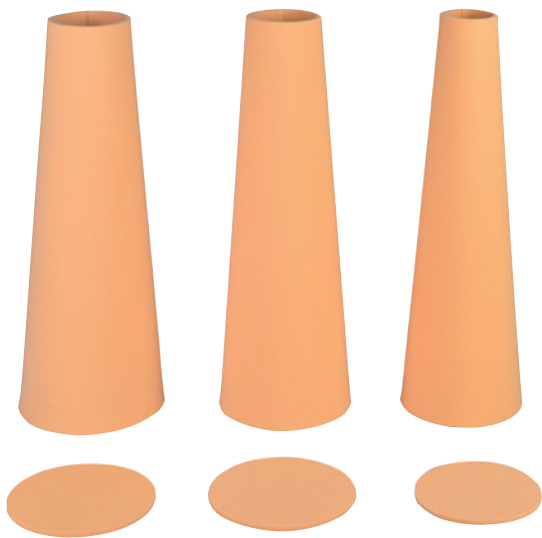

## Streifycone for Soft-Socket

### Designated use

- pre-fabricated conus with distal end cap for time-saving production of soft-sockets

### Characteristics

- the material Streifyfoam (expanded soft-polyethylene) is optimally thermoplastic mouldable at 130 °C
- does not shrink, features excellent restoring force and is easily cleaned with ph-neutral soapy water

### Material

- closed-cell foam material and therefore very hygienic and non-irritant to the skin
- thickness: 5 mm, Shore A 35 – 40
- height: 425 mm for all sizes

Distal circ.	Proximal circ.	Ø distal end cap	Size	Item-No.
190 mm	390 mm	116 mm	S	6S1/S
230 mm	420 mm	136 mm	M	6S1/M
260 mm	470 mm	136 mm	L	6S1/L

 Heat lying flat in the infrared-oven (50M25) or standing upright in the heating cabinet (50M4) at 130 °C for approx. 10 – 15 minutes, then pull it over the dry cast model. For bonding the distal end cap, it is best to use our forte contact glue (118P13).

# Socket Comfort – Care Products & Accessories

In addition to the right liner, stump sock or sheath the gentle care and cleaning is important for high wearing comfort and skin protection. The care products from Streifeneder help the user to protect liner and skin, offer maximum hygiene and are easy to use.





# Socket Comfort – Care Products & Accessories



## Stump Care Agent PC30V

- stump care cream for external application, for the wearers of prostheses, as well as of other orthopaedic appliances and accessories
- prevents pressure and rubbing zones
- also conditions and strengthens the skin
- applicable for decubitus prophylaxis
- free of skin irritating substances

Volume	Item-No.
100 ml	10H1/100
250 ml	10H1/250



## Skin Care -Washing Lotion-

- cleans skin, prostheses, orthoses and liners with gentle care
- prevents skin irritations
- pH-neutral
- prevents body odour

Volume	Item-No.
250 ml	10H2



## Skin Care -Skin Protection Cream-

### Material

- silicoderm F, based on silicone-oil

### Application

- skin protection especially prior to and after casting works

### Characteristics

- develops an efficient protective film
- protects the physiological acid film
- economical use

PU = 1 tube

Content	Item-No.
35 ml	10H3



## Skin Care -Moisturising Lotion-

- conditions and regenerates dry and stressed skin
- protects against pressure and rubbing
- soothes skin irritations
- reduces sweat and odour

Volume	Item-No.
250 ml	10H4

# Socket Comfort – Care Products & Accessories



## Skin Care -Spray-



- spray for liners without textile covers
- the silicone liner receives a slide-on layer with the spray
- for easier putting on and off
- optimal grip by rapid vaporescence

Volume	Item-No.
200 ml	10H5
Refill bottle for Skin Care Spray 1000 ml	10H5/1



## Rotary Cutter

- cuts textile and liner material without difficulty
- the rotary blade facilitates contouring accuracy
- blade diameter 45 mm

Item-No.
166P55

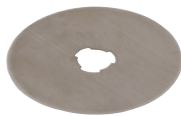

## Replacement Blade

- for item 166P55

Cut of blade	Diameter	Item-No.
straight	45 mm	166P55/1



## Wave Cut Scissors

- cutting surface with serrated edge (1 wave 2 cm)
- for cutting and shaping Silicone- and Contex-Gel-Liners
- prevents tearing of cutting edges of liners caused by stretching
- improves distribution of circular shearing forces on the residual limb skin, which reduces skin irritations

Length	Item-No.
240 mm	166P36



# Socket Comfort – Stump Care

The demands on a stump sock are very high and manifold. The outer surface should be as smooth as possible, yet hard-wearing; while the collar should be elastic and prevent incisions of the skin. When directly worn on the skin, breathability, anti-allergic properties, rapid drying, good adherence and close meshed textiles are desirable to protect against friction. Stump socks from Streifeneder are available in various designs depending on the desired use – e.g. made of terrycloth, cotton or nylon, or suitable for ak-, bk- or arm-stumps.

With our exclusive selection of DAW protection covers, we offer protective covers with appraised quality and reliability. The exceptionally thin seam – a special trademark- distinguishes the nylon DAW protection cover. The use of new manufacturing machines allows for a yet improved and even more regular knitting pattern.



Sharp-edged socket trim lines result in premature wear of the stump sock. Therefore, please make sure to manufacture round edges.

Please take into account that the hem of the DAW nylon protective cover (10 cm) is not to be measured when determining the length. This hem is turned back over the rim of the socket to prevent the sock from sliding into the socket. At the same time, it covers the socket trim line and thereby protects the clothing.



- Available with or without pin hole, in different thicknesses, materials and colours
- Large selection of stump socks for above-knee, below-knee and arm stumps
- Increases durability life of gel liners
- Postoperative compression therapy
- Compensates stump volume changes
- Additional cushioning towards liner or inner socket
- Thermoactive
- Long-lasting

# Socket Comfort – Streifyderm

Streifyderm refers to our cushioning stump socks with integrated polymer gel.

With the Streifyderm stump socks, Streifeneder ortho.production is able to offer additional high-quality products for a below the knee prosthetic fitting. Streifeneder stump socks stand out due to their excellent combination of elastic nylon fabric ("Spandex") and softly cushioning polymer gel.

 Please wash all socks with mild, pH-neutral soap and lukewarm water.



The polymer-gel contains medical mineral oils, that offer the following advantages

- Nurturing the skin through constant release of mineral oils during wearing.
- Reduction of mechanical stress (shearing forces) on the already particularly stressed stump skin.
- Cushions and protects particularly delicate stump areas such as the edge of the shinbone, fibula head and the end of the residual limb.
- Has a pressure discharging effect on the above mentioned stump areas.
- Adaption of the Streifyderm stump socks to the stump shape in the course of wear.

# Socket Comfort – Compression Stump Socks

In order to reduce the post-operative oedema after an amputation, the attending physician will prescribe a compressing stump sock therapy. The compression stump socks (shrinkers) are used to reduce the post-operative swelling and to bring the residual limb into proper shape and constant volume.

Depending on the size of the oedema and the pressure sensitivity of the user, two different compression classes are available (compression class Ccl. 1 = light compression; compression class Ccl. 2 = medium compression).

Regular use of the compression stump sock provides correct modelling of the residual limb and preparation of the limb for the prosthesis. Mainly, the goal is to achieve a cylindrical or conical shape of the residual limb; which will simplify putting on the leg prosthesis; resp. the compression socks will prevent development of new oedemas after taking the leg prosthesis off.

 Please use our chart „compression therapy“ in the instruction manual to note the daily volume of the residual limb.

Users sensitive to pressure can also wear two compression socks of compression class Ccl. 1 (light) over each other to increase the effect.

To simplify putting on the compression stump socks, please wear rubber gloves.

Please inform your customer that long fingernails or sharp-edged rings may damage the compression stump sock.



# Socket Comfort – Stump Socks

## Stump Sock StreifyDerm

2 mm polymer gel

- for the prosthetic provisioning of the lower extremities
- stump sock consisting of nylon textures and coated with 2 mm polymer gel



Gel length / size	Stump length	Circ. distal	Circ. proximal	Item-No.
20 cm / 1	25 – 34 cm	17 – 24 cm	17 – 26 cm	26A10/1
25 cm / 2	38 – 44 cm	18 – 28 cm	18 – 32 cm	26A10/2
25 cm / 3	38 – 44 cm	20 – 34 cm	20 – 38 cm	26A10/3
33 cm / 4	43 – 49 cm	20 – 34 cm	20 – 38 cm	26A10/4
25 cm / 5	43 – 49 cm	23 – 37 cm	23 – 43 cm	26A10/5
33 cm / 6	46 – 54 cm	23 – 37 cm	23 – 43 cm	26A10/6
33 cm / 7	46 – 54 cm	28 – 42 cm	28 – 49 cm	26A10/7
33 cm / 8	46 – 54 cm	31 – 50 cm	31 – 56 cm	26A10/8

## Stump Sock StreifyDerm Cushion

3 mm polymer gel

- for the prosthetic provisioning of the lower extremities
- consisting of nylon texture and coated with 3 mm polymer gel



Gel length / size	Stump length	Circ. distal	Circ. proximal	Item-No.
20 cm / 1	25 – 34 cm	17 – 24 cm	17 – 26 cm	26A20/1
25 cm / 2	38 – 44 cm	18 – 28 cm	18 – 32 cm	26A20/2
25 cm / 3	38 – 44 cm	20 – 34 cm	20 – 38 cm	26A20/3
33 cm / 4	43 – 49 cm	20 – 34 cm	20 – 38 cm	26A20/4
25 cm / 5	43 – 49 cm	23 – 37 cm	23 – 43 cm	26A20/5
33 cm / 6	46 – 54 cm	23 – 37 cm	23 – 43 cm	26A20/6
33 cm / 7	46 – 54 cm	28 – 42 cm	28 – 49 cm	26A20/7
33 cm / 8	46 – 54 cm	31 – 50 cm	31 – 56 cm	26A20/8

## Stump Sock StreifyDerm Endurance

two nylon textures and 2 mm polymer gel

- for the prosthetic provisioning of the lower extremities
- consisting of two nylon textures and with 2 mm polymer gel in between



Gel length / size	Stump length	Circ. distal	Circ. proximal	Item-No.
20 cm / 1	25 – 34 cm	17 – 24 cm	17 – 26 cm	26A30/1
25 cm / 2	38 – 44 cm	18 – 28 cm	18 – 32 cm	26A30/2
25 cm / 3	38 – 44 cm	20 – 34 cm	20 – 38 cm	26A30/3
33 cm / 4	43 – 49 cm	20 – 34 cm	20 – 38 cm	26A30/4
25 cm / 5	43 – 49 cm	23 – 37 cm	23 – 43 cm	26A30/5
33 cm / 6	46 – 54 cm	23 – 37 cm	23 – 43 cm	26A30/6
33 cm / 7	46 – 54 cm	28 – 42 cm	28 – 49 cm	26A30/7
33 cm / 8	46 – 54 cm	31 – 50 cm	31 – 56 cm	26A30/8

# Socket Comfort – Stump Socks



## Below-Knee Compression Stocking

with silicone-knops grip top, antibacterially fitted



### Mode of action

- compression therapy; the respective compression class is determined by the responsible medical doctor. Standard-compression pressure for compression class 1 (light) is 18 - 21 mm Hg, (2,4 – 2,8 hPa); for compression class 2 (medium) it is 23 – 32 mm Hg, (3,1 – 4,3 hPa)

### Indication

- for reduction of post-surgical oedema after below-knee amputation
- for preparation and plaster-casting of the residual limb for the prosthesis
- for oedemata prevention after taking the leg prosthesis off

### Contraindication

- open wounds
- non-reducible oedemata
- stasis dermatitis (dermatitis varicosa)
- peripheral artery occlusive disease (PAOD)
- thrombophlebitis acuta
- decompensated heart insufficiency

### Material

- circular knitted fabric, antibacterially fitted
- 78 % polyamide
- 22 % elastane
- with silicone-knops grip top

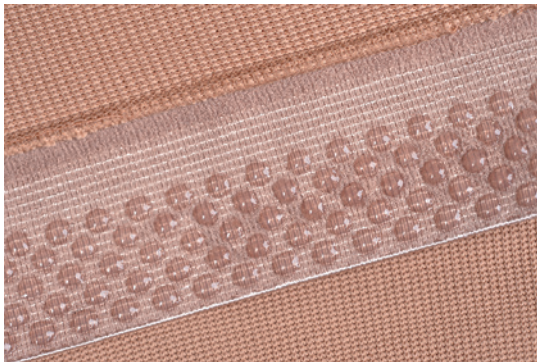

Size	Circ. f	Circ. e	Circ. c	Length L
XS	41 cm	31 cm	29 cm	30, 38, 46 cm
S	44 cm	34 cm	32 cm	30, 38, 46 cm
M	47 cm	37 cm	35 cm	30, 38, 46 cm
L	50 cm	40 cm	38 cm	30, 38, 46 cm
XL	53 cm	43 cm	41 cm	30, 38, 46 cm
XXL	56 cm	46 cm	44 cm	30, 38, 46 cm

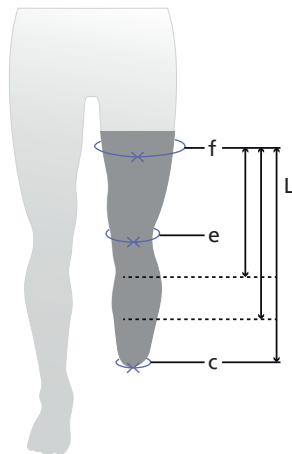

Compression class 1: 452A1 + size + length / Compression class 2: 452A2 + size + length

Ordering example: 452A1/XS30 = compression class 1, size XS, length 30 cm



For documentation of the volume, use the chart in the instruction manual.



# Socket Comfort – Stump Socks



## Above-Knee Compression Stocking

with hip attachment, antibacterially fitted



### Mode of action

- compression therapy; the respective compression class is determined by the responsible medical doctor. Standard-compression pressure for compression class 1 (light) is 18 - 21 mm Hg, (2,4 – 2,8 hPa); for compression class 2 (medium) it is 23 – 32 mm Hg, (3,1 – 4,3 hPa)

### Indication

- for reduction of post-surgical oedema after above-knee amputation
- for preparation and plaster-casting of the residual limb for the prosthesis
- for oedemata prevention after taking the leg prosthesis off

### Contraindication

- open wounds
- non-reducible oedemata
- stasis dermatitis (dermatitis varicosa)
- peripheral artery occlusive disease (PAOD)
- thrombophlebitis acuta
- decompensated heart insufficiency

### Material

- circular knitted fabric, antibacterially fitted
- 78 % polyamide
- 22 % elastane
- with hip attachment



Size	Circ. g	Circ. e	Length L
XS	44 cm	31 cm	20, 25, 30, 35 cm
S	48 cm	34 cm	20, 25, 30, 35 cm
M	52 cm	37 cm	20, 25, 30, 35 cm
L	56 cm	40 cm	20, 25, 30, 35 cm
XL	60 cm	43 cm	20, 25, 30, 35 cm
XXL	64 cm	46 cm	20, 25, 30, 35 cm

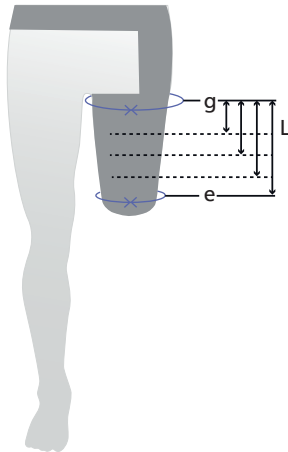

Compression class 1: 451A1 + size + length / Compression class 2: 451A2 + size + length

Ordering example: 451A1/XS20 = compression class 1, size XS, length 20 cm



For documentation of the volume, use the chart in the instruction manual.



# Socket Comfort – Stump Socks



## DAW-Nylon-Sheath

standard type, conical universal shape



### Designated use

- the DAW nylon sheath is worn directly on the skin to keep the skin dry and to prevent irritation by reducing friction, which provides better adhesion between skin and prosthesis
- optimal compression of the tissue, therefore ideal support of blood reflux and stimulation of the capillary vessels

### Characteristics

- the soft inner surface is comfortable on the skin
- the whipped seam of the cuff marks the outside
- the smooth outside facilitates getting into the prosthesis resp. makes it easier to put on additional sock

### Material

- 100 % PA (nylon)
- colour: white
- very fine, smooth and openly knitted quality
- the knitting technique prevents ladders
- machine washable at 30 °C



Form	Length in cm	Item-No.
A	20, 25, 30, 35, 40, 45, 50, 55, 60, 65, 70, 75	25A50/A..
B	25, 30, 35, 40, 45, 50, 55, 60, 65, 70, 75, 80	25A50/B..
C	20, 25, 30, 35, 40, 45, 50, 55, 60, 65, 70, 75	25A50/C..
D	20, 25, 30, 35, 40, 45, 50, 55, 60, 65	25A50/D..
E	20, 25, 30, 35, 40, 45, 50	25A50/E..

Dimension sketch:

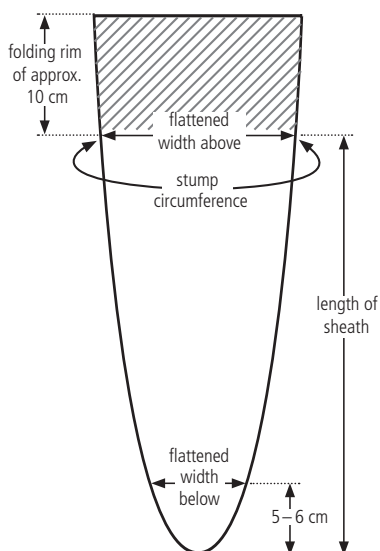

Forms

Form	Stump circ.*	Approx. width above x below sheath
A	40-50 cm	15 x 9 cm, 20 x 10 cm
B	50-60 cm	20 x 10 cm
C	more than 60 cm	25 x 17 cm
D	30-40 cm	15 x 9 cm
E	up to 30 cm	arm stump sock

Ordering example: 25A50/A20 = form A, length 20 cm

Forms:

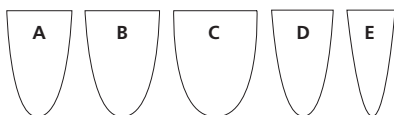



# Socket Comfort – Stump Socks



## DAW-Nylon-Sheath

for knee disarticulation



### Designated use

- the DAW nylon sheath is worn directly on the skin to keep the skin dry and to prevent irritation by reducing friction, which provides better adhesion between skin and prosthesis
- optimal compression of the tissue, therefore ideal support of blood reflux and stimulation of the capillary vessels

### Characteristics

- the soft inner surface is comfortable on the skin
- the whipped seam of the cuff marks the outside
- the smooth outside facilitates getting into the prosthesis resp. makes it easier to put on additional sock
- the special contour at the distal end optimally adapts to the anatomical shape of the knee disarticulation residual limb

### Material

- 100 % PA (nylon)
- colour: white
- very fine, smooth and openly knitted quality
- the knitting technique prevents ladders
- machine washable at 30 °C



Form	Thigh circ.	Knee circ.	Length in cm	Item-No.
A	up to 50 cm	up to 35 cm	40, 45, 50, 55	25A51/A..
B	up to 60 cm	up to 35 cm	40, 45, 50, 55	25A51/B..

Ordering example: 25A51/A40 = form A, length 40 cm

Dimension sketch:

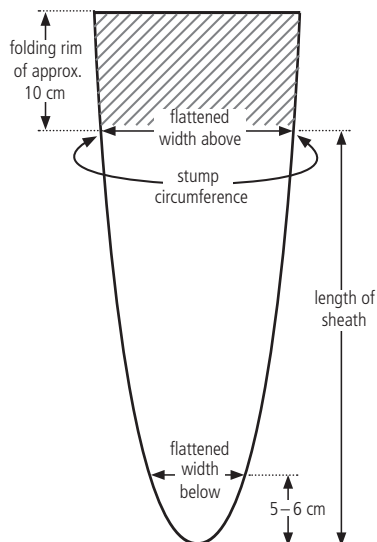

Forms:

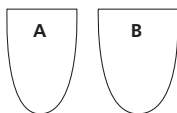

# Socket Comfort – Stump Socks



## Terrycloth Stump Sock for BK-amputees

thick quality, straight shape



### Designated use

- very effective to even out differing volume, due to voluminous inside with terry-cloth loops
- item-no. 25A10 with vulcanised rubber opening for pin, to be worn over any liner
- item-no. 25A11 without opening for pin, may be worn directly on the skin or over any sheath, e.g. item-no. 25A50

### Characteristics

- very comfortable wear due to high cotton content
- the terry-cloth loops on the inside provide excellent cushioning effect and climate management, since this voluminous type may store abundant moisture
- very stretchable and yet dimensionally stable knitting technique

### Material

- 85 % (CO) cotton, 15 % (PA) textured (crinkled) polyamide silk
- machine washable up to 60 °C



Length in cm	Colour	Item-No. with hole for pin	Item-No. without hole for pin
20, 25, 30, 35, 40, 45, 50, 55, 60	blue	25A10/.B	25A11/.B
20, 25, 30, 35, 40, 45, 50, 55, 60	peach	25A10/..H	25A11/..H
20, 25, 30, 35, 40, 45, 50, 55, 60	black	25A10/..S	25A11/..S
20, 25, 30, 35, 40, 45, 50, 55, 60	turquoise	25A10/..T	25A11/..T
20, 25, 30, 35, 40, 45, 50, 55, 60	white	25A10/..W	25A11/..W

Dimension sketch:

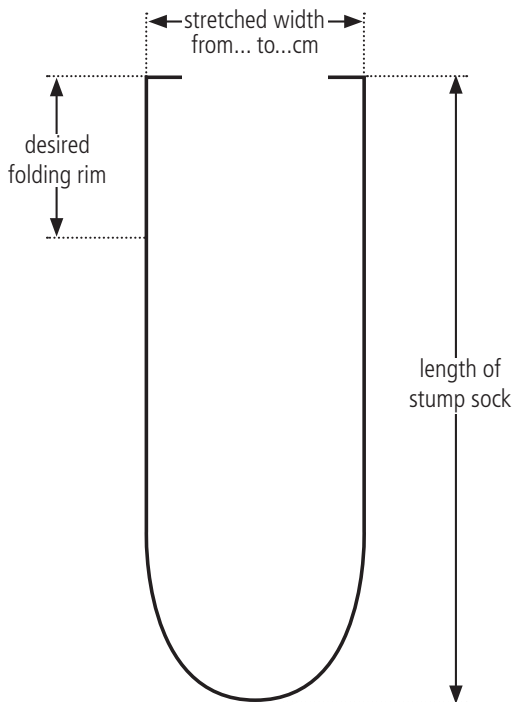

Ordering example: 25A11/20B = without hole for pin, length 20 cm, colour blue. In colours green, yellow, purple or red available upon request.

**S** If a cuff is desired, its length must be added to the stocking length. Size is determined by sock length only. For bigger circumferences of the residual limb, the sock length becomes shorter due to stretching. The sock stretches from approx. 10 cm up to 20 cm.

# Socket Comfort – Stump Socks



## Terrycloth Stump Sock for BK-amputees

thick quality, straight shape, with wool content



### Designated use

- very effective to even out differing volume, voluminous knit ware due to crinkled fibre
- item-no. 25A12 with vulcanised rubber opening for pin, to be worn over any liner
- item-no. 25A13 without opening for pin, may be worn directly on the skin or over any sheath e.g. item-no. 25A50

### Characteristics

- the terry-cloth loops on the inside provide excellent cushioning effect and climate management, since this voluminous type may store abundant moisture
- very comfortable wear and warming effect due to wool content
- during wearing, the stocking shape adapts to the individual shape of the residual limb

### Material

- 50 % (WO) wool, 25 % PA (acryl), 10 % PA (polyamid), 15 % (PA) textured (crinkled) polyamide silk
- colour: off-white
- machine washable up to 60 °C



Length in cm	Type	Item-No.
25, 35, 40, 45, 55, 65	with hole for pin	25A12/..
25, 30, 35, 40, 45, 50, 55, 60, 65	without hole for pin	25A13/..

Ordering example: 25A12/25 = with hole for pin, length 25 cm

**I** If a cuff is desired, its length must be added to the stocking length. Size is determined by sock length only. For bigger circumferences of the residual limb, the sock length becomes shorter due to stretching. The sock stretches from approx. 10 cm up to 20 cm.

Dimension sketch:

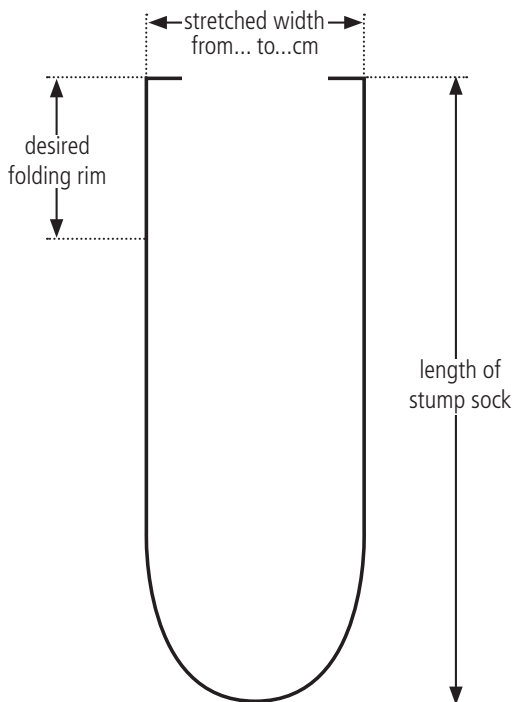

# Socket Comfort – Stump Socks



## Terrycloth Stump Sock for BK-amputees

extra thick quality, straight shape, with Lycra content



### Designated use

- very effective to even out differing volume, due to voluminous inside with terry-cloth loops
- this type without opening for pin may be worn over any liner or directly on the skin
- an additional sheath, e.g. item-no. 25A50 may be worn directly on the skin in order to keep the skin dry
- light compression effect, due to Lycra content

### Characteristics

- extremely stretchable (more than double of unstretched width) due to Lycra content
- very high dimensional stability by Lycra content, i.e. the material always retightens to its original shape
- very comfortable wear due to high cotton content
- the terry-cloth loops on the inside provide excellent cushioning effect and climate management, since this voluminous type may store abundant moisture



### Material

- 95 % (CO) cotton, 5 % (EL) elastane (Lycra)
- colour: white
- machine washable up to 60 °C

Length in cm	Type	Item-No.
20, 25, 30, 35, 40, 45, 50, 55, 60, 65, 75	without hole for pin	25A14/..

Ordering example: 25A14/20 = length 20 cm

**I** If a cuff is desired, its length must be added to the stocking length. Size is determined by sock length only. For bigger circumferences of the residual limb, the sock length becomes shorter due to stretching. The sock stretches from approx. 7,5 cm up to 19 cm.

Dimension sketch:

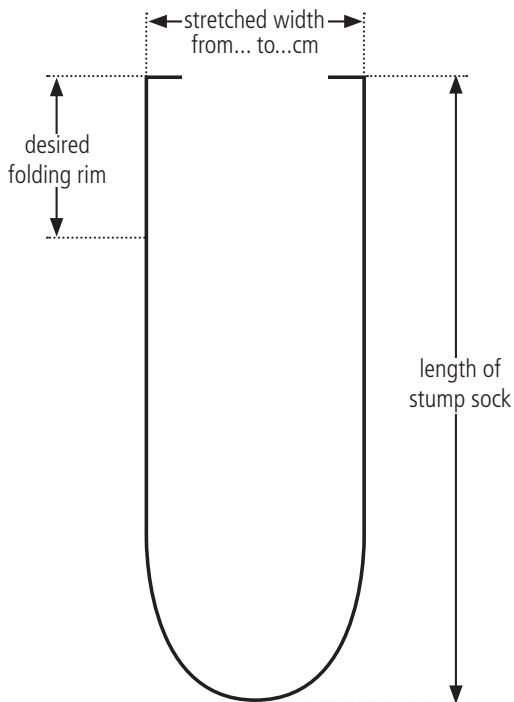

# Socket Comfort – Stump Socks



## Cotton Stump Sock for BK-amputees

thin, smooth quality, straight shape, with high elastane content



### Designated use

- item-no. 25A20 with vulcanised rubber opening for pin, to be worn over any liner
- item-no. 25A21 without opening for pin, may be worn directly on the skin
- effective to even out differing volume
- light compression effect, due to high elastane content

### Characteristics

- very high stretching ability and shape stability due to high elastane content, i.e. the material always retightens to its original shape
- very comfortable wear and skin tolerance due to high cotton content

### Material

- 85 % (CO) cotton, 15 % (EL) elastane
- colour: white
- machine washable up to 60 °C

Length in cm	Type	Item-No.
20, 25, 30, 35, 40, 45, 50, 55, 60	with hole for pin	25A20/..
20, 25, 30, 35, 40, 45, 50, 55, 60, 70, 75	without hole for pin	25A21/..

Ordering example: 25A20/20 = with hole for pin, length 20 cm

**I** If a cuff is desired, its length must be added to the stocking length. Size is determined by sock length only. For bigger circumferences of the residual limb, the sock length becomes shorter due to stretching. The sock stretches from approx. 8 cm up to 16 cm.

Dimension sketch:

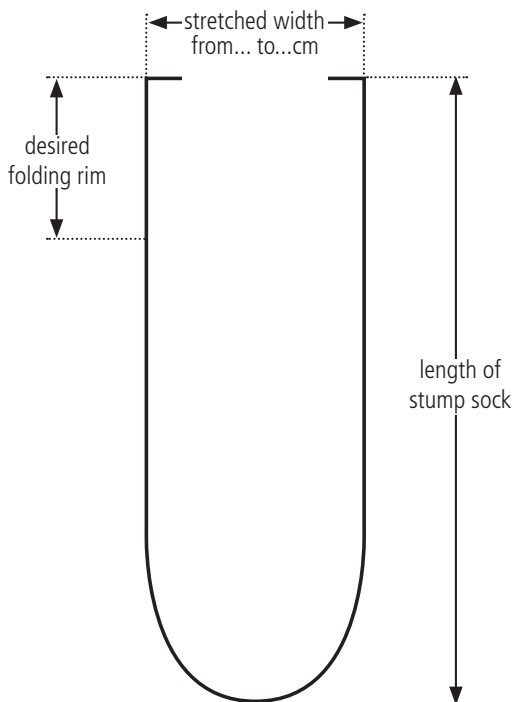

# Socket Comfort – Stump Socks



## Cotton Stump Sock for BK-amputees

thin, smooth quality, straight shape, with elastane content



### Designated use

- item-no. 25A23 with vulcanised rubber opening for pin, to be worn over any liner
- item-no. 25A24 without opening for pin, may be worn directly on the skin
- effective to even out differing volume
- light compression effect, due to elastane content

### Characteristics

- very high stretching ability and shape stability due to high elastane content, i.e. the material always retightens to its original shape
- very comfortable wear and skin tolerance due to high cotton content
- flat, single layer cuff

### Material

- 95 % (CO) cotton, 5 % (EL) elastane
- colour: off-white
- machine washable up to 60 °C



Length in cm	Type	Item-No.
20, 25, 30, 35, 40, 45, 50, 55	with hole for pin	25A23/..
20, 25, 30, 35, 40, 45, 50, 55, 60	without hole for pin	25A24/..

Ordering example: 25A23/20 = with hole for pin, length 20 cm

**I** If a cuff is desired, its length must be added to the stocking length. Size is determined by sock length only. For bigger circumferences of the residual limb, the sock length becomes shorter due to stretching. The sock stretches from approx. 8 cm up to 16 cm.

Dimension sketch:

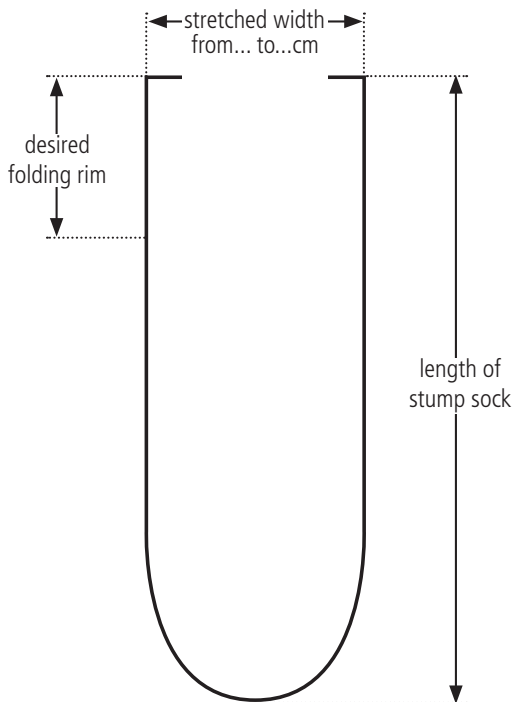

# Socket Comfort – Stump Socks



## Nylon Stump Sock for BK-amputees

very fine-knit, thin quality, straight shape



### Designated use

- to be worn over the liner to effectively protect the liner

### Characteristics

- with vulcanised rubber opening for pin
- the whipped seam of the cuff marks the inside; the smooth side of the knitted fabric must face outwards

### Material

- 100 % PA (nylon), knitted fabric, similar to opaque tights
- colour: white
- machine washable up to 60 °C

Length in cm	Type	Item-No.
20, 25, 30, 35, 40, 45, 50, 55	with rubber vulcanised pin hole	25A31/..

Ordering example: 25A31/25 =with rubber vulcanised pin hole, length 25 cm

**I** If a cuff is desired, its length must be added to the stocking length. Size is determined by sock length only. For bigger circumferences of the residual limb, the sock length becomes shorter due to stretching. The sock stretches from approx. 11 cm up to 20 cm.



Dimension sketch:

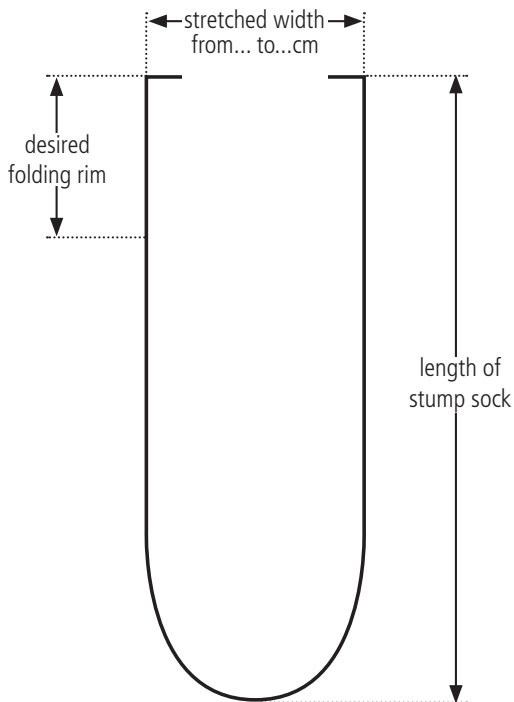

# Socket Comfort – Stump Socks



## Nylon Stump Sock for BK-amputees

thin, fine-knit quality, straight shape, large pin opening

### Designated use

- to be worn over the liner to effectively protect the liner

### Characteristics

- the pin opening, diam. approx. 4 cm, is formed by a knitted cuff (e.g. suitable for a KISS® Lanyard system)
- the whipped seam of the cuff marks the inside; the smooth side of the knitted fabric must face outwards

### Material

- 100 % PA (nylon), open knitted fabric, similar to opaque tights
- colour: white
- machine washable up to 60 °C



Length in cm	Type	Item-No.
25, 35, 45	with knitted hole for pin	20A61/..

Ordering example: 20A61/25 = length 25 cm

**S** If a cuff is desired, its length must be added to the stocking length. Size is determined by sock length only. For bigger circumferences of the residual limb, the sock length becomes shorter due to stretching. The sock stretches from approx. 10 cm up to 20 cm.

Dimension sketch:

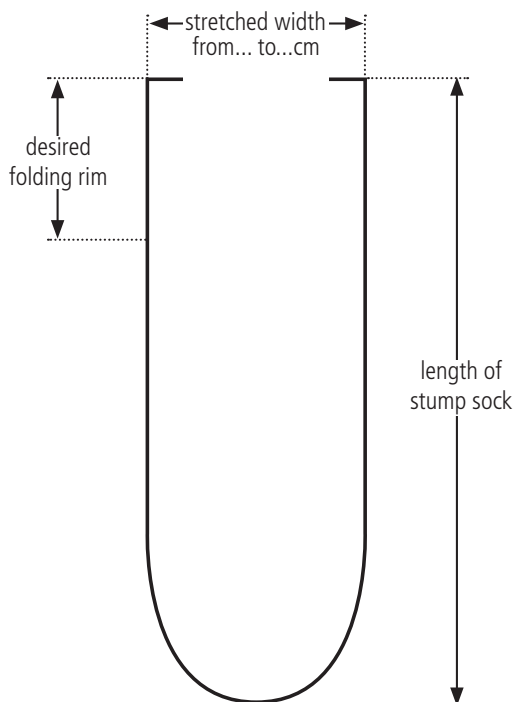



# Socket Comfort – Stump Socks



## Terrycloth Stump Sock for AK-amputees

thick quality, conical form



### Designated use

- very effective to even out differing volume, due to voluminous inside with terry-cloth loops
- item-no. 25A15 with vulcanised rubber opening for pin, to be worn over any liner
- item-no. 25A16 without opening for pin, may be worn directly on the skin or over any sheath e.g. item-no. 25A50

### Characteristics

- conical shape, therefore with lateral flat cover seam
- very comfortable wear due to high cotton content
- the terry-cloth loops on the inside provide excellent cushioning effect and climate management, since this voluminous type may store abundant moisture
- very stretchable and yet dimensionally stable knitting technique

### Material

- 85 % (CO) cotton, 15 % (PA) textured (crinkled) polyamide silk
- colour: white
- machine washable up to 60 °C



Length in cm	Type	Item-No.
20, 25, 30, 35, 40, 45, 50, 55, 60	with hole for pin	25A15/..
20, 25, 30, 35, 40, 45, 50, 55, 60	without hole for pin	25A16/..

Ordering example: 25A15/20 = with hole for pin, length 20 cm

**I** If a cuff is desired, its length must be added to the sock length. Size is determined by sock length only. For bigger circumferences of the residual limb, the sock length becomes shorter due to stretching. The sock stretches from approx. 16 cm up to 27 cm.

Dimension sketch:

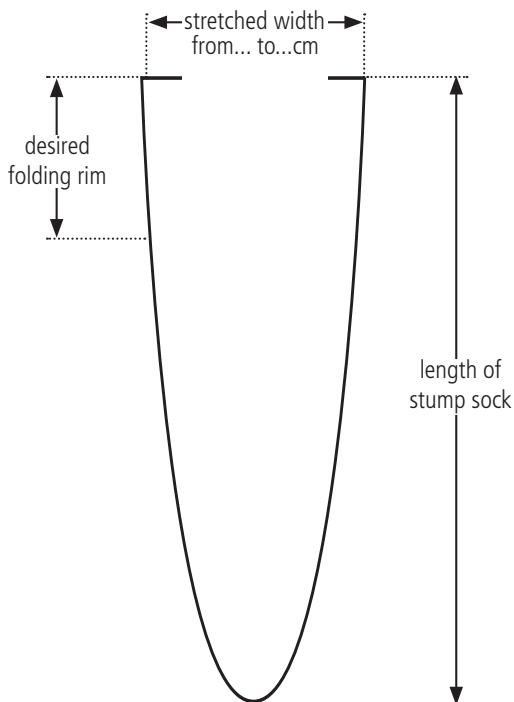

# Socket Comfort – Stump Socks



## Cotton Stump Sock for AK-amputees

thin, smooth quality, conical shape, with elastane content



### Designated use

- with vulcanised rubber opening for pin for ak-amputees
- to be worn over any liner and effective to even out differing volume

### Characteristics

- extremely stretchable and dimensional stability by elastane content, i.e. the material always retightens to its original shape
- very comfortable wear and skin tolerance due to high cotton content
- flat, single layer cuff
- conical shape, with flat lateral cover seam

### Material

- 95 % (CO) cotton, 5 % (EL) elastane
- colour: off-white
- machine washable up to 60 °C

Length in cm	Type	Item-No.
25, 30, 35, 40, 45, 50, 55	with hole for pin	25A25/..



Ordering example: 25A25/25 = length 25 cm

**I** If a cuff is desired, its length must be added to the sock length. Size is determined by sock length only. For bigger circumferences of the residual limb, the sock length becomes shorter due to stretching. The sock stretches from approx. 14 cm up to 28 cm.

Dimension sketch:

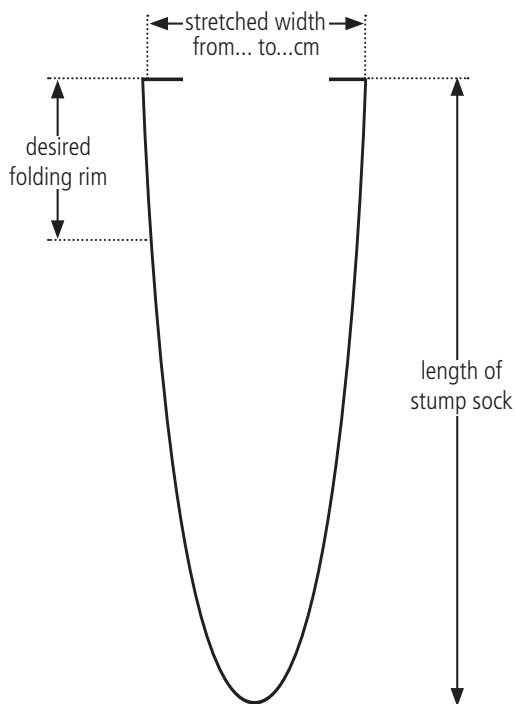

# Socket Comfort – Stump Socks



## Nylon Stump Sock for AK-amputees

very fine-knit, thin quality, conical shape



### Designated use

- with vulcanised rubber opening for pin for ak-amputees
- to be worn over the liner to effectively protect the liner

### Characteristics

- the whipped seam of the cuff marks the inside; the smooth side of the knitted fabric must face outwards
- conical shape, therefore with lateral flat cover seam

### Material

- 100 % PA (nylon), knitted fabric, similar to opaque tights
- colour: white
- machine washable up to 60 °C

Length	Type	Item-No.
25, 30, 35, 40, 45, 50, 55	with hole for pin	25A35/..

Ordering example: 25A35/25 = length 25 cm



**S** If a cuff is desired, its length must be added to the sock length. Size is determined by sock length only. For bigger circumferences of the residual limb, the sock length becomes shorter due to stretching. The sock stretches from approx. 19 cm up to 32 cm.

Dimension sketch:

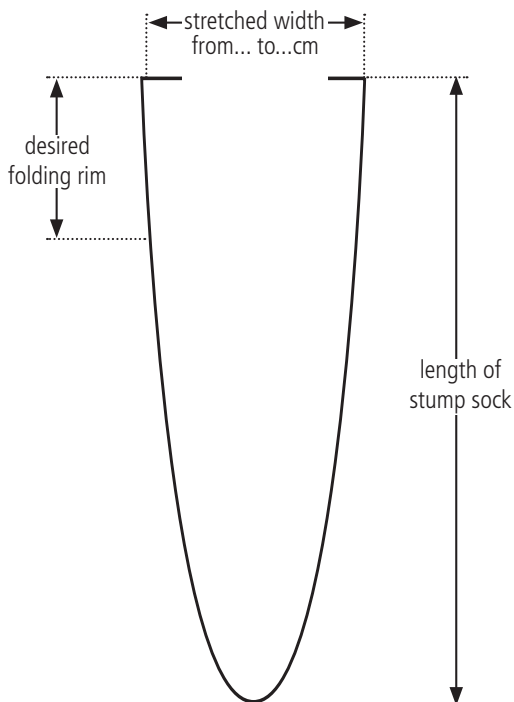

# Socket Comfort – Stump Socks



## Wool Stump Sock for AK- and BK-amputees

strong quality, 3 threads, conical shape



### Designated use

- effective to even out differing volume
- strong fabric (pink seam)
- this type without opening for pin may be worn directly on the skin
- between skin and stump sock a sheath, e.g. item-no. 25A50 must be worn

### Characteristics

- very comfortable wear and warming effect due to wool content
- during wearing, the stocking shape adapts to the individual shape of the residual limb
- provides excellent cushioning effect and climate management, since wool may absorb abundant moisture, without feeling damp

### Material

- 70 % (WO) wool, 30% (CV) rayon
- colour: off-white
- machine washable at 30 °C

Wool stump sock with hole for pin available upon request.



Length in cm	Form in cm	Item-No.
30, 35, 40, 45, 50, 55, 60, 65, 70, 75	20 x 10 unstretched, 25 x 13 stretched	20A74/..

Ordering example: 20A74/30 = length 30 cm



If a cuff is desired, its length must be added to the length of the sock.

Dimension sketch:

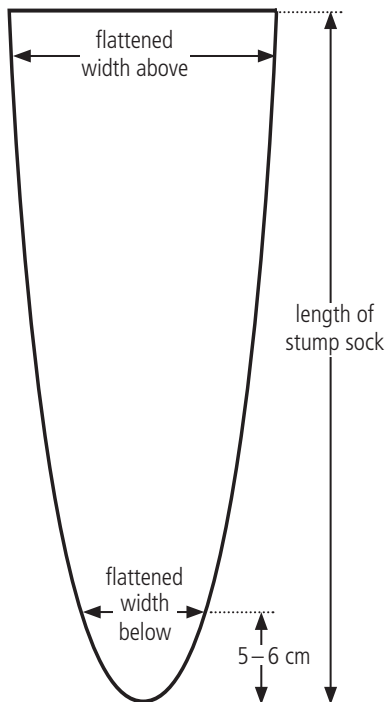

# Socket Comfort – Stump Socks



## Wool Stump Sock for AK- and BK-amputees

medium strong quality, 2 threads, conical form



### Designated use

- effective to even out differing volume
- medium strong fabric (white seam)
- this type without opening for pin may be worn directly on the skin
- between skin and stump sock a sheath, e.g. item-no. 25A50 must be worn

### Characteristics

- very comfortable wear and warming effect due to wool content
- during wearing, the stocking shape adapts to the individual shape of the residual limb
- provides excellent cushioning effect and climate management, since wool may absorb abundant moisture, without feeling damp

### Material

- 70 % (WO) wool, 30 % (CV) rayon
- colour: off-white
- machine washable at 30 °C

Wool stump sock with hole for pin available upon request.



Length in cm	Form in cm	Item-No.
25, 30, 35, 40, 45, 50	15 x 9 unstretched, 19 x 12 stretched	20A57/..
25, 30, 35, 40, 45, 50, 55, 60, 65, 70	20 x 10 unstretched, 25 x 13 stretched	20A58/..

Ordering example: 20A57/25 = length 25 cm, form 15 x 9 cm (unstretched) resp. 19 x 12 cm (stretched)

 If a cuff is desired, its length must be added to the length of the sock.

Dimension sketch:

